

Simple Rollovers

A simple rollover graphic is one that changes somehow when the mouse rolls over it. The language used to write rollovers is JavaScript. Luckily for us, when we use DreamWeaver we don't need to know any scripting, the application does it automatically for us.

The first step in creating a rollover graphic is to create the graphics. This is often done using PhotoShop or FireWorks. In this workshop, the graphics we'll use have already been created. A simple rollover graphic requires a minimum of two separate graphics: an "off" state and an "on" state. When you are creating your own graphics for your own site, be aware that these two graphics need to have the same height and width measurements.

For this exercise, we will be switching nav bar graphics that look like text. When the mouse rolls over one of the items, the graphic will change appearance.

From This (off)

Home

To This (on)

home

Where We're Going

1. Before we even start DreamWeaver, let's look at the **simple rollovers** folder. Locate it inside of your Class/DreamWeaver folders and open it up.
2. Double-click on **index.html** to launch the program and view a sample of what we're going for. This is just a simple table with six images that look like text.
3. Press **F12** to launch your page in a web browser. Move your arrow over one of the text items. You'll see that it switches from text alone to text on a little fluffy colored cloud. As you move your arrow off of this item, it switches back to regular text.



4. Move your arrow onto the word **Dragons**. See that this graphic changes also. Click on the word **Dragons**. It is a link to the **dragons.html** web page. Click on the **Go Home** text on that page to switch back.
5. Close the web browser window to return to DreamWeaver. Then close this document. It is just a sample of what we're hoping to end up with.
6. Now open up the **images** folder located inside the **simple rollovers** folder. This folder contains all the image pairs required for our six links. When these images were created, they were named in a way to make it easy for the web page designer to know which buttons go together, and which button represents off (... *button.gif*) and which represents on (... *-on.gif*).

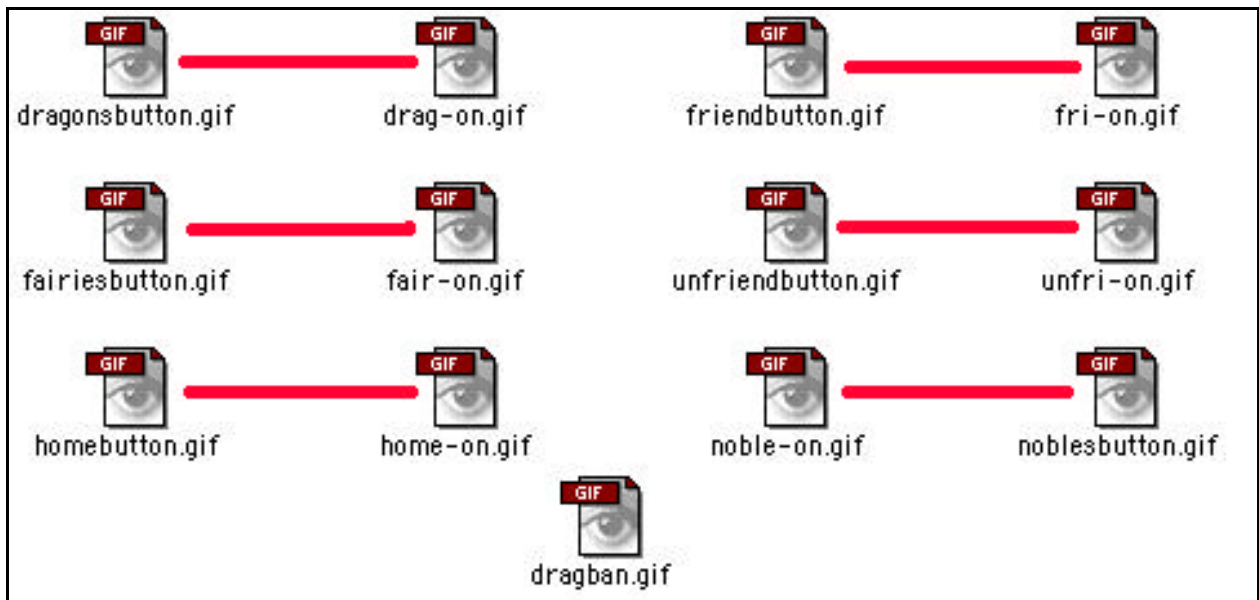

*Note: the **dragban.gif** image is not part of the rollover images. That's why it doesn't have a partner. It is just the banner image at the top of the dragons.html page.*

7. I'm just pointing out this relationship between images to you so that it will be easier to understand once we start putting all the pieces together. You can close these folders.

Getting Started

8. Launch DreamWeaver. Using the Site window, define the **simple rollovers** folder as your ROOT folder.
9. Create a new document (File – New). Save it into the simple rollovers folder.
10. Type **Command+J** (**⌘+J**) to open the Page Properties dialog box. (Or select Modify CPage Properties.) Give your document page a title and choose a background color.

11. Create a table:

3 rows	0 cell padding
2 columns	0 cell spacing
500 pixels wide	0 border

12. Click in the first cell. In the Properties Inspector, set

width = 108 pixels	height = 36 pixels
---------------------------	---------------------------

Tab into each other cell and repeat the settings.

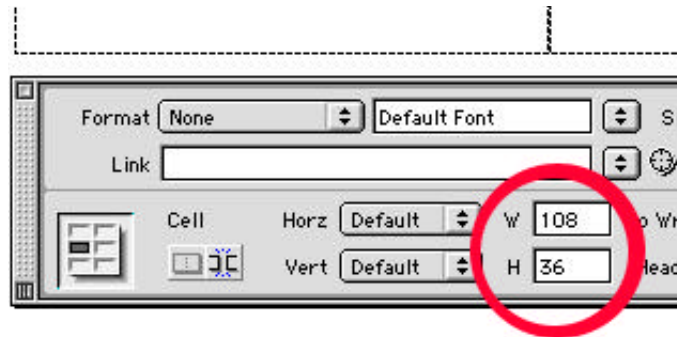

13. Click in the first cell again, where we'll place the Home button as follows:

- On the Common Objects palette, click on the Insert Rollover Image icon. The following dialog box appears:

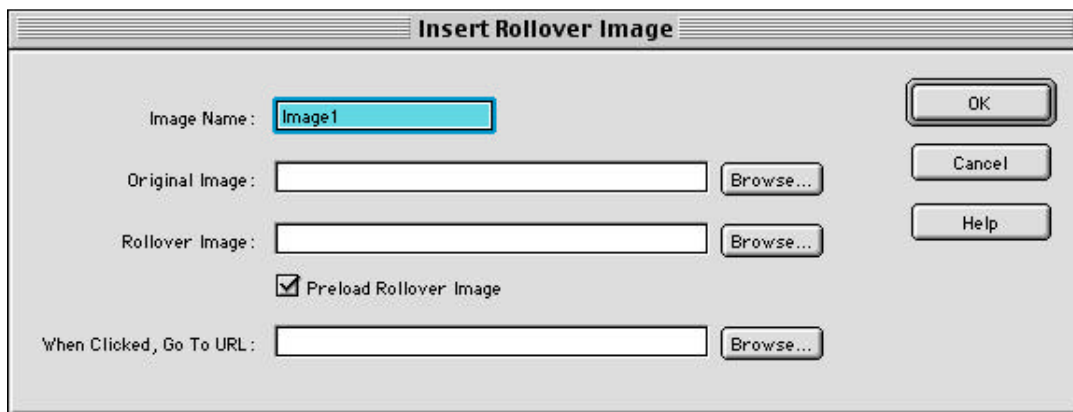

- Name the image (tip: use the same name as the button – **home**, in this case).
- Click on the Browse... button to the right of the Original Image: box.
- In the simple rollovers/images folder, locate and double-click on the **homebutton.gif**.

- Click on the Browse... button to the right of the Rollover Image: box.
 - In the simple rollovers/images folder, locate and double-click on the **home-on.gif**.
 - Leave the Preload Rollover Image box checked.
 - Since this is the home page, this image won't really be a link, so leave the last box empty. Click **OK**.
14. Back in the table, click into another cell. In this cell we will insert the Dragon button.
- Follow the procedure above to insert the dragon button, using **dragonsbutton.gif** as the original image, and **drag-on.gif** as the rollover image.
 - This time we want a link to the document **dragons.html**. Click on the Browse... button to the right of When Clicked, Go To URL:
 - Go up one level – out of the images folder and into the simple rollovers folder. Locate **dragons.html** and double-click on it.
 - Your Insert Rollover Image dialog box should look like this. Click **OK**.

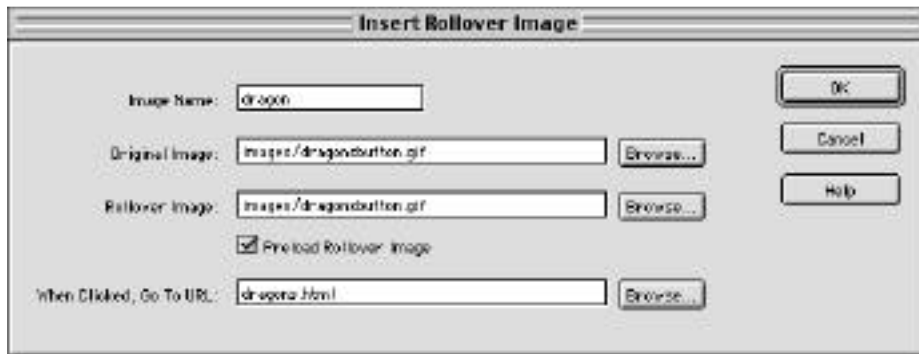

15. Continue placing rollover images into all the cells of the table as follows:
- | | | |
|---------------------------|----|---------------------|
| fairiesbutton.gif | CE | fair-on.gif |
| friendbutton.gif | CE | fri-on.gif |
| unfriendbutton.gif | CE | unfri.gif |
| noblesbutton.gif | CE | noble-on.gif |

The pages for these links don't exist in this folder, so there's no need to create links to them.

16. Save your document. Preview in both browsers – Netscape and Internet Explorer. Check to make sure the link to **dragons.html** works.

Incidentally, the link saying "Go Home" on the **dragons.html** page is set to return to our demo document, not yours. Use the Back Button in the browser instead.

Advanced Rollovers/Swap Images

In the previous example we created a simple rollover that switches one image for another when the mouse rolls over the original image.

This example is a little more elaborate. When the mouse rolls over the original image, it will be replaced with a rollover image, just like in the previous example. In addition, another image will appear in a blank area of the page, along with a description of the image.

Where We're Going

1. Once again, before we get started let's look at where we're headed. Open the **advanced rollovers** folder. Locate it inside of your Class/DreamWeaver folders and open it up.
2. Double-click on **index.html** to launch the program and view a sample of what we're going for. Right now the page doesn't look like much. There's a banner at the top of the page, a nav bar under the banner, and a 2-celled empty table under that.
3. Press **F12** to launch your page in a web browser. At first it looks even emptier than it did in DreamWeaver, because now you can't see the table. But move your mouse over one of the dragon names. The color of the text changes, and below that a picture of the dragon and a description appears. As you move across the nav bar to other dragons, the images switch. When the cursor has moved off all the names, the images disappear again.
4. Close your browser window and the index.html document. This is the document we are going to re-create together.
5. Open up the images folder located in the advanced rollovers folder.



As before, there is more than one image affiliated with each original. In this case there are three other images that will appear when the mouse rolls over the original.

As you can see, they have been named to make it easy to keep track of what goes where.

(...1.gif) is the original image

(...-on.gif) is the rollover replacement image

(...pict.gif) is the picture of the dragon

(...text.gif) is an image of the text describing the dragon.

In addition, we have two blank images – blank1.gif and blank2.gif. These are placeholders that need to be put into the table.

Getting Started

1. Launch DreamWeaver. Using the Site window, define the **advanced rollovers** folder as your ROOT folder.
2. Create a new document (File – New). Save it into the advanced rollovers folder.
3. Insert the banner for the top of the page. Click on the Insert Image icon on the Common Objects palette. Locate the **dragban.gif** image (Class docs\Dreamweaver \advanced rollovers \images folder) and double-click.
4. Type **Command+J** (**⌘+J**) to open the Page Properties dialog box. (Or select Modify \Page Properties.) Give your document page a title. To set the page background, click on the Background palette box. The cursor turns into an eyedropper. Move it to the banner and click on the blue in the banner. Click **OK** to close this window.
5. Click at the end of the banner to set your I-beam, then hit the Return key twice to put some space between the banner and the nav bar.
6. Insert a 1-row, 4-cell table, **500** pixels wide, no borders, spacing or padding.
7. Click in the first cell and set the width = **108**, height = **36**. Repeat settings for the rest of the cells.
8. Click at the end (outside) of the table. Hit Return twice to put some space between the nav bar and the images.
9. Insert a 1-row, 2-cell table, **500** pixels wide, no borders, spacing or padding.
10. Click in the first cell and set the width = **147**, height = **144**. Click in the second cell and set the width = **300**, height = **144**.

Note: these figures were determined because they are the same size as the images. Remember that all images that are going into the same area need to be the same size, and you need to make sure that size is big enough to hold the images.

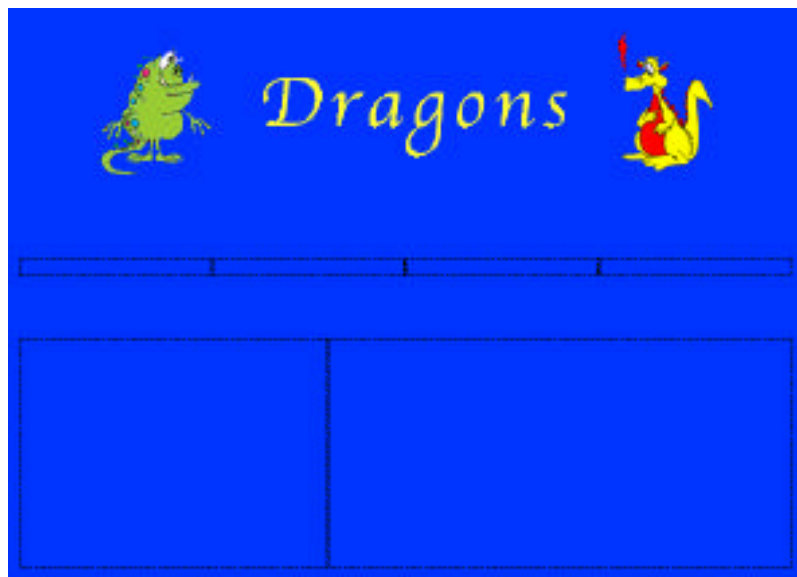

Inserting the Original Images

When we created simple rollovers there was a convenient little rollover images icon in the Common Objects palette. It is not quite so convenient with advanced rollovers (but that's OK because you have a LOT more options). The first step is to insert original images into each spot where an image will be. In the case of the dragon names, that is easy to see – each dragon has a name in the nav bar. However, we also need to place images into the area below the nav bar where the dragon picture/description will go. Since these areas appear empty to start with, we'll insert blank images into those spots.

One more important thing to know: images **MUST** be named when they are inserted. Actually, if you don't name them, DreamWeaver will name them for you . . . *untitled1*, *untitled2*, *untitled3*. You can just imagine how confused you would be when you go to replacing rollovers if you can't remember just what *untitled5* is a picture of. So follow my instructions and **name** your images!

1. Click in the first cell of the nav bar table. Insert the image **Edgar1.gif**. In the Properties Inspector, click in the little white box in the upper left and name this image **edgartitle**.



2. Click in the second cell of the nav bar table. Insert the image **jasper1.gif**. Name this image **jaspertitle**.
3. Click in the third cell; insert the image **puff1.gif**; name this **pufftitle**.
4. Click in the fourth cell; insert the image **nessie1.gif**; name this **nessietitle**.
5. Now if you're not absolutely positive that you named these images, click back on each one and look in the PI to make sure they are titled. OK, the Nav bar is set up.
6. Click in the first cell of the lower table. Insert the image **blank1.gif**. BE SURE to name this image **blank1**. This image is a 1 pixel x 1 pixel blank spot. But when we do rollovers, images need to be the same size. So in order to make this big enough, change the width = **147**, height = **144** in the Properties Inspector. Now it's a big blank image.



- The Swap Image dialog box appears. As you can see, there is a list of all the images we've put into this document. The way this works is that you select which original image you want to replace and then you go find the image you want to replace it with and set that up in the Set Source box. Be sure not to click the OK key until you're told to.

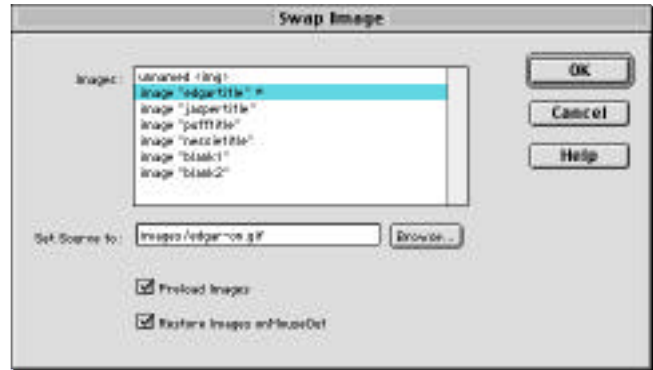

- The image **edgartitle** is already selected. Click on the Browse... button. Find the **edgar-on.gif** image and double-click on it to set it up in the Set Source box.
- Next, we want to replace the blank1 image, so click on image **“blank1”**. Click on the Browse... button. Find the **edgarpict.gif** image and double-click on it to set it up in the Set Source box.
- Last, click on image **“blank2”** to replace it. Click on the Browse... button. Find the **edgartext.gif** image and double-click on it to set it up in the Set Source box.
- Now click on the **OK** button to return to your document. Save your work.
- Normally I like to create all the swaps before previewing, but I recommend that you preview at this point. Press **F12** to see your page in the browser. Move the mouse over Edgar in the nav bar. The text color should change **AND** a picture of Edgar **AND** his description should appear under the Nav Bar.

If all those things didn't happen, then there is a problem that needs to be solved before bothering to create the rest of the swaps.

- If everything worked, then close the browser to return to DreamWeaver. Repeat the procedure above to create the rest of the image swaps:

Original image	Rollover image	Blank1	Blank2
jasper1.gif	jasper-on.gif	jasperpict.gif	jaspertext.gif
puff1.gif	puff-on.gif	puffpict.gif	pufftext.gif
nessie1.gif	nessie-on.gif	nessiepict.gif	nessietext.gif

- Press **F12** to preview your page in the browser. Move the mouse over each dragon name in the nav bar. The text color should change **AND** a picture of Edgar **AND** his description should appear under the Nav Bar. Return to DreamWeaver and press **Command-F12** to preview in the other browser.
- Save your document. Close it.

Flash Buttons

There is an easy way to create simple rollover buttons without having to create the two images first in a different program, such as PhotoShop or FireWorks. Since you create the buttons inside of Dreamweaver, they can easily and quickly be changed or edited. These buttons are called Flash Buttons, even though you don't use the Flash application to create them.

Remember that Flash is an animation program created by Macromedia, the same company that created DreamWeaver. When you create Flash Buttons inside DreamWeaver, they actually are Flash objects and are saved with the **.swf** suffix, just as they would have if they had been created in the Flash application.

There are several advantages to using Flash Buttons created in DreamWeaver:

- ❖ You can use any font on your system and visitors to your site don't need to have that font installed on their computers.
- ❖ They are easily updated – with just a few clicks you can change the text and appearance of the button.
- ❖ It is so easy to create these buttons that it makes it easy to maintain a consistent look and feel to your site without spending a lot of time designing your own rollover art.

Of course, with the good comes the bad. Or not necessarily bad, but there *is* a catch:

- ❖ The user must have the Flash plug-in installed on their computer in order to see Flash Button animations correctly. The Flash plug-in is free and available at the Macromedia web site. But some of your viewers may not want to get the plug-in just to view your cool buttons.

Creating Flash Buttons

1. Inside (**Class docs**œ**Dreamweaver** œ**flash buttons** folder) there is the document **flash.html**. Open it.
2. This is very similar to the document we used in our last exercise. However, the second table where the descriptions of the dragons appeared has been deleted. Instead, we are going to create Flash buttons in the Nav table that will link to separate **.html** pages that describe each dragon.
3. Click inside the first cell of the Nav bar table. Then click on the Insert Flash Button icon in the Common Objects palette.

A dialog box will appear:



4. First, choose a style from the extensive Style scroll-down box. Just scroll up and down the list, clicking on styles until you find one you like. You can preview the “on” look of the button by moving your cursor up and over the Sample button at the top of the window. (By the way, once the “on” view is showing, it sometimes takes awhile for it to go back to “off.” It’s not instantaneous by moving the mouse back off of the sample.)
5. In the Button Text: box, type what you want the button to say. In this exercise, type **Edgar**, because this first button will link to a web page about Edgar the Dragon.

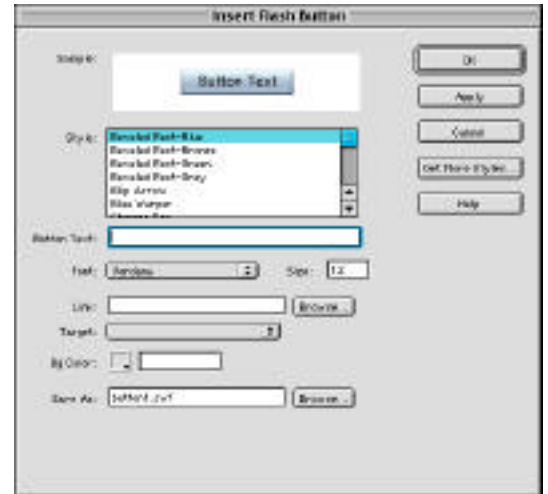

6. Choose a font from the list. All fonts installed on your computer are available to you here. Type in a size. Remember that our table is only 36 pixels high, so make the text on the button somewhere between 14-24 pts.
7. Since we want this button to link to another web page, click on the Browse... button next to the Link: box. Browse to the document **edgar.html** and double-click to select it.
8. In this particular exercise, we’d like the new web page to open up in its own window, rather than replacing what’s in the existing box. So in the Target: box, choose **_blank**. This coding forces links to open up in new browser windows.
9. For the background color of the button, click in the tiny square box. Your cursor changes to an eyedropper. Move it over to the blue background of your document and click to select that color. You could, of course, choose a different color, but then your button will look dorky.
10. In the Save As: box, give your button a name (**edgar.swf**). Keep the .swf suffix. It is a good idea to click on the Browse... button and maneuver so that you’re saving your new button into the Images folder located inside the flash buttons folder. (You don’t need to browse to the images folder, but if you don’t, all your flash buttons will be littering your .html folder.



11. Click the OK key to create the button.
12. When you return to your document, if you don’t like the appearance of your button, you can double-click on it to reopen this dialog box to change the appearance or wording of the text.
13. Tab over to each of the next cells in the table and create Flash buttons for Jasper, Puff and Nessie, linking each of them to thehtml document related to them.



14. Click **F12** to preview your document. When you roll over each of these buttons, they subtly change colors. As you click on one of these buttons, a new browser window should open up to a description of your selected dragon. Just close that window to return to your main page.
15. Close your web browsers and click on your DreamWeaver document. Save and close it.